

Atrium Segment

CARACTERÍSTICA GENERAL

Escalera modular grande, a la vista es muy ligera. Sólida y confortable. Construcción de uso universal, recomendada tanto en viviendas privadas como en oficinas. Se la puede instalar en forma recta, en forma de arco con uno o dos descansos secundarios.

DATOS TÉCNICOS DEL COMPLETO

CONSTRUCCIÓN:

- 15 elementów
- altura entre: 270 – 320 cm
- altura entre peldaños: 17 – 20 cm
- mínimo hueco en el piso superior (forjado): depende de la forma de la escalera
- color propuesto: plata – gris (RAL 9006)

BALUSTRADA:

- lateral, con la posibilidad de montaje a cualquiera de los lados (laterales) de la escalera.
- Rellena con 6 barras horizontales de acero inoxidable \varnothing 6 mm pasamanos plástico de diámetro 40 mm,
- color: negro, gris, café

PELADAÑOS:

- de madera (haya natural), lacados
- largo: desde 80 – 100 cm, ancho: 27 cm, grosor: 4 cm
- forma rectangular y en forma de cometa para acoplarse al giro



Escaleras ATRIUM SEGMENT / SEGMENT PLUS

15 elementos (1 desanso)

ejemplos de composiciones

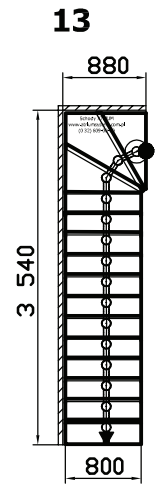
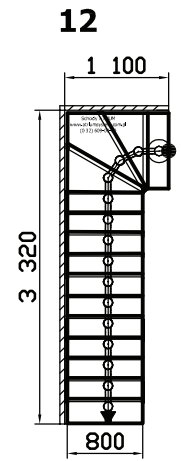
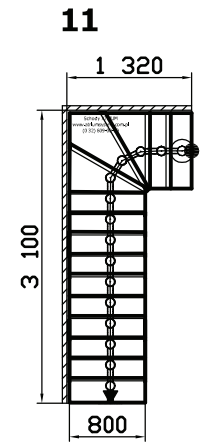
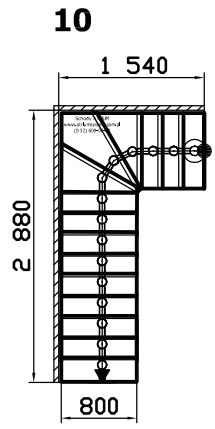
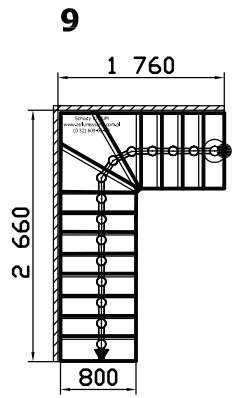
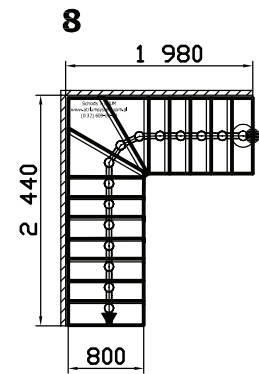
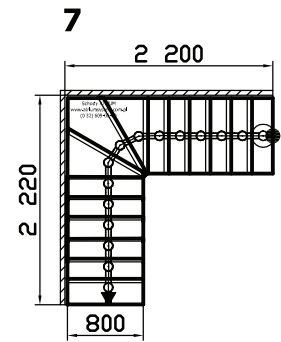
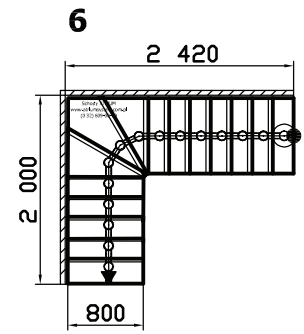
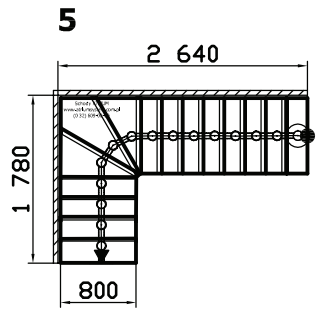
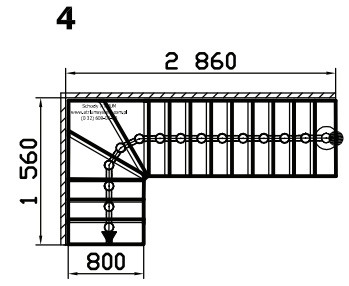
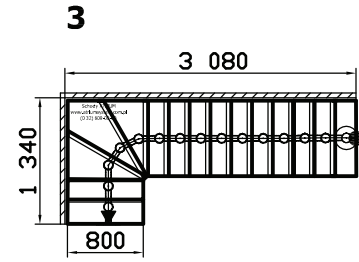
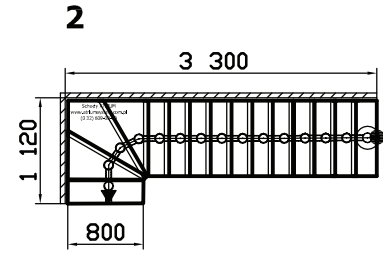
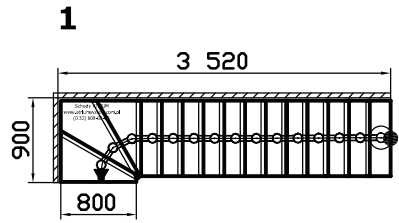

Escaleras ATRIUM SEGMENT / SEGMENT PLUS

15 elementos (2 desansos)

ejemplos de composiciones

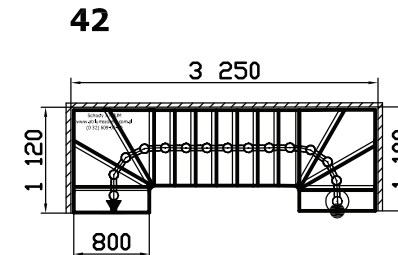
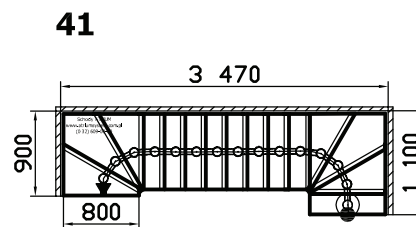
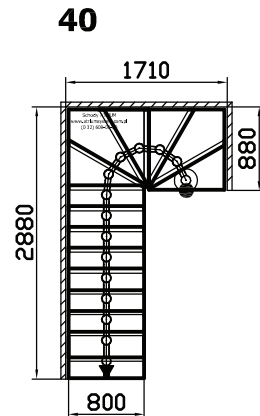
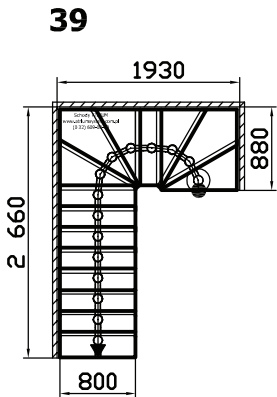
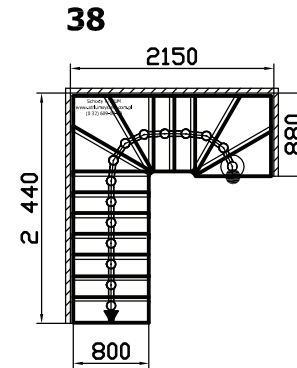
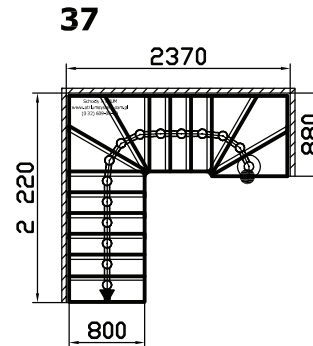
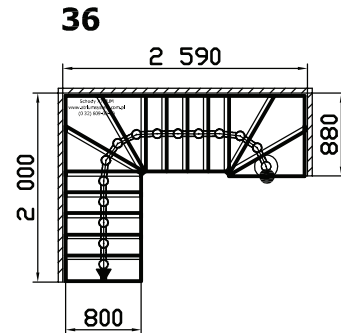
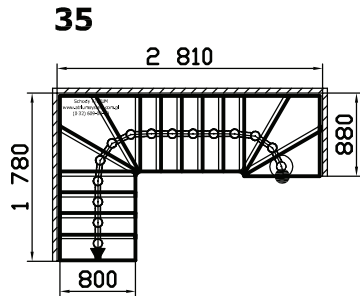
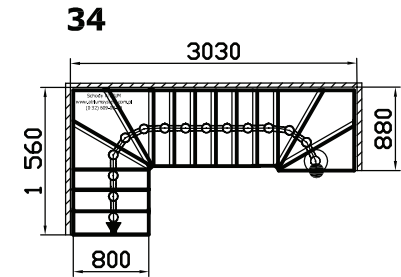
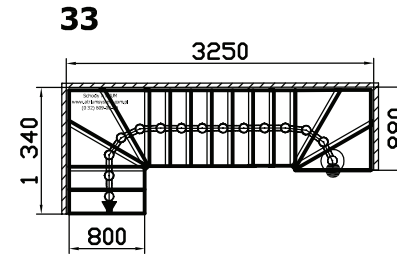
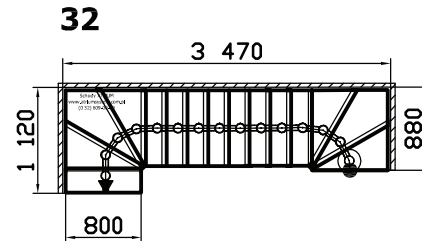
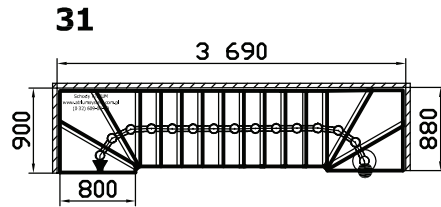

Escaleras ATRIUM SEGMENT / SEGMENT PLUS

15 elementos (2 desansos)

ejemplos de composiciones

43

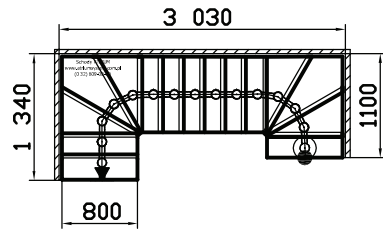

44

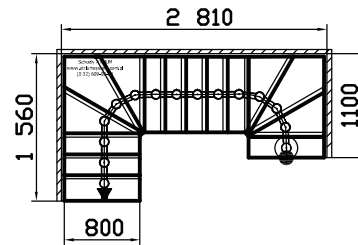

45

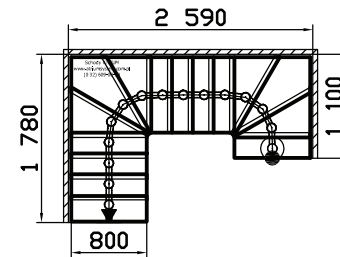

46

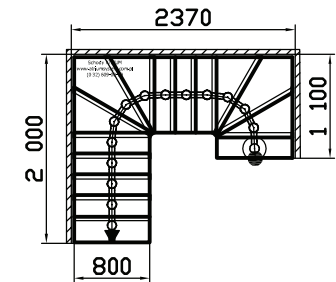

47

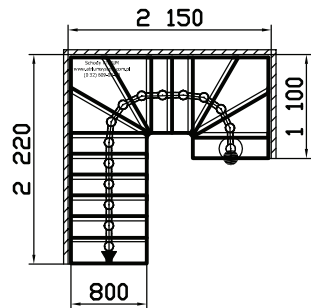

48

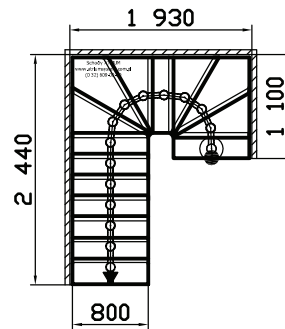

49

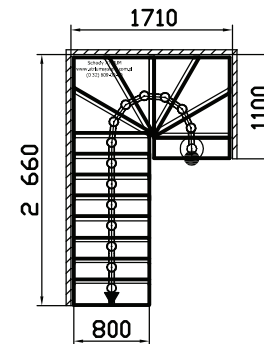

50

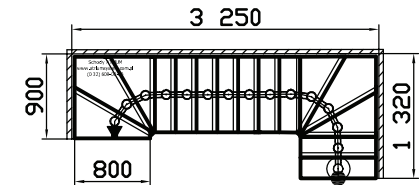

51

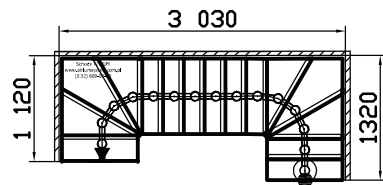

52

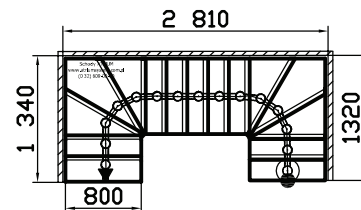

53

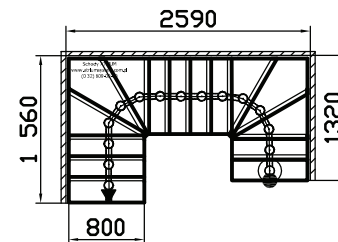

54

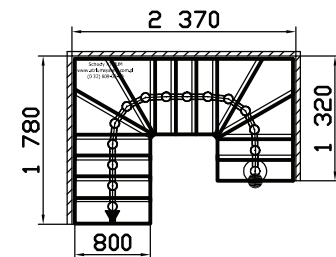

Escaleras ATRIUM SEGMENT / SEGMENT PLUS

15 elementos (2 desansos)

ejemplos de composiciones

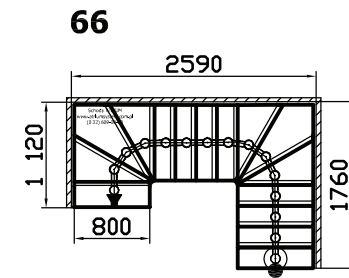
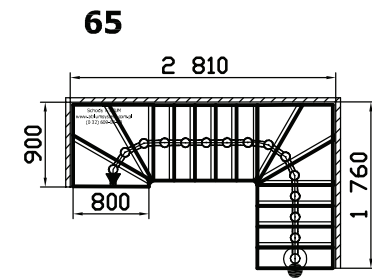
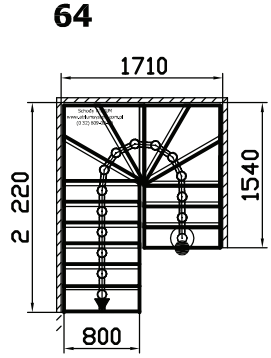
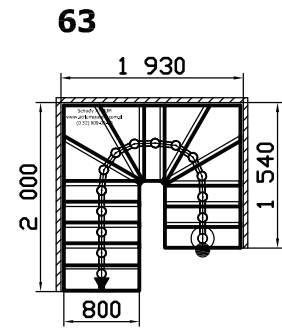
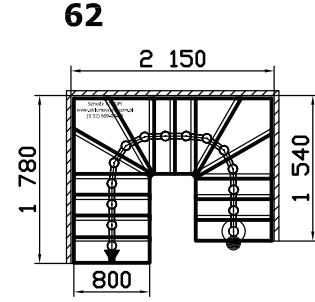
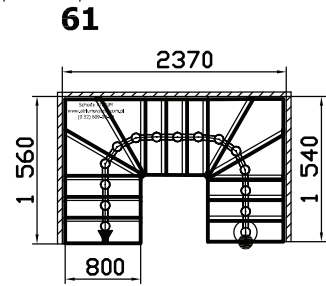
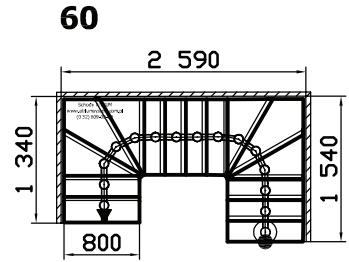
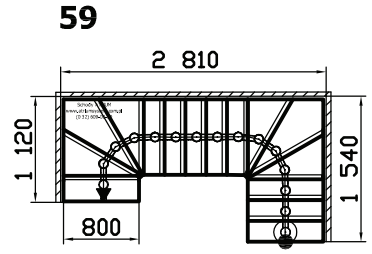
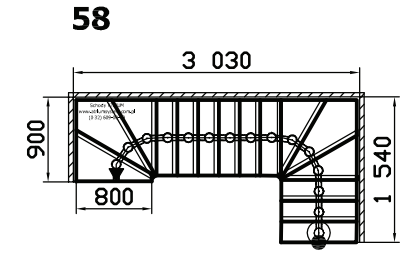
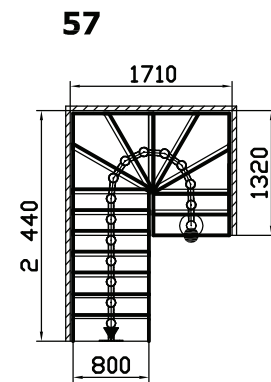
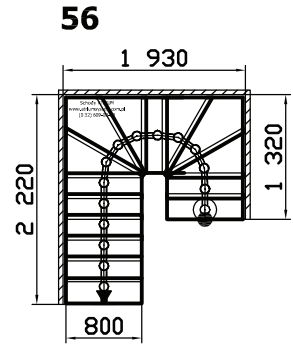
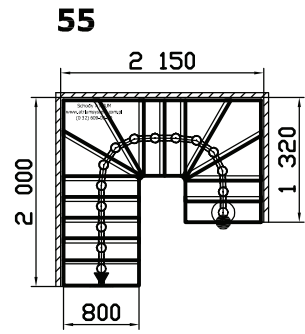

Escaleras ATRIUM SEGMENT / SEGMENT PLUS

15 elementos (2 desansos)

ejemplos de composiciones

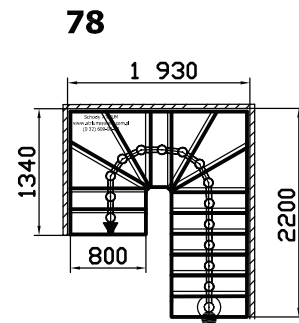
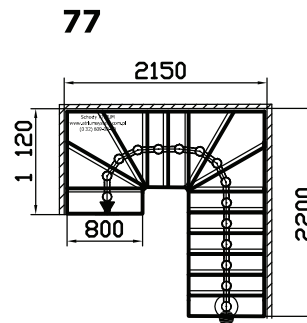
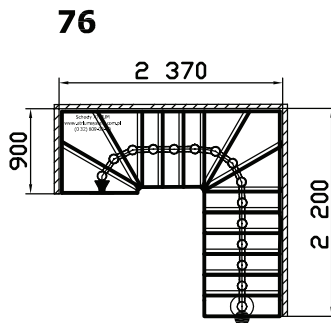
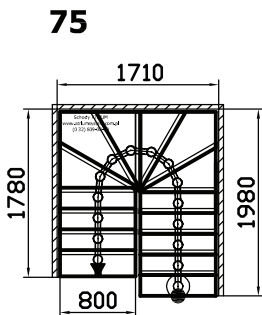
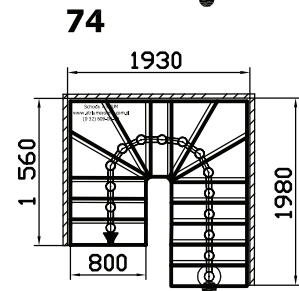
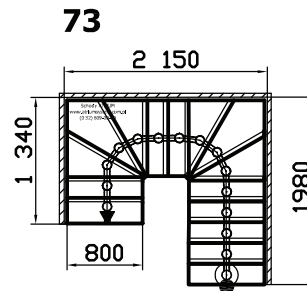
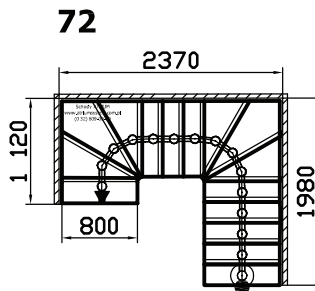
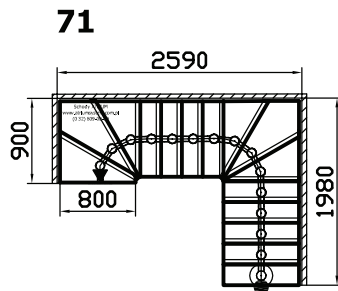
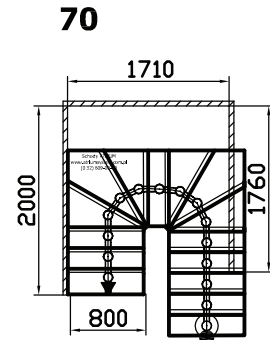
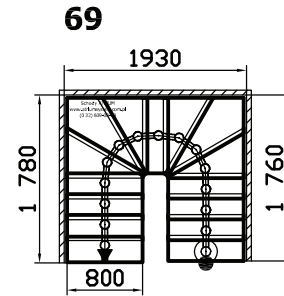
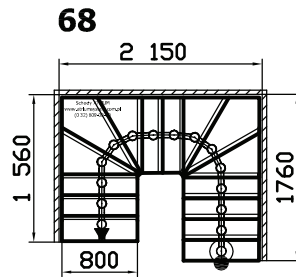
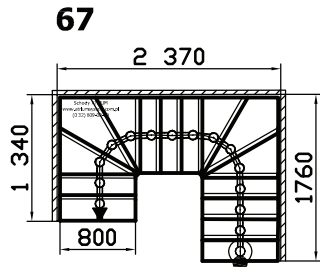

Escaleras ATRIUM SEGMENT / SEGMENT PLUS

15 elementos (2 desansos)

ejemplos de composiciones

